



固體電子有限公司 Solitronics Engineering Ltd.

Tel : (852) 2730-8145

Fax : (852) 2730-3245

2202, Perfect Ind. Bldg., 31 Tai Yau St., Kowloon, Hong Kong S.A.R., China E-mail: info@solitronics.com

IEC Ø22mm Compact/Mono-Block Non-Lighted Push-Button & Selector-Switch

Date: **25th July 2012**

Ø22mm Compact/Mono-Block Push-Button & Selector-Switch

Part Number (18-Digits): **SE-22MB-XX-XX-XX-XX-XX**





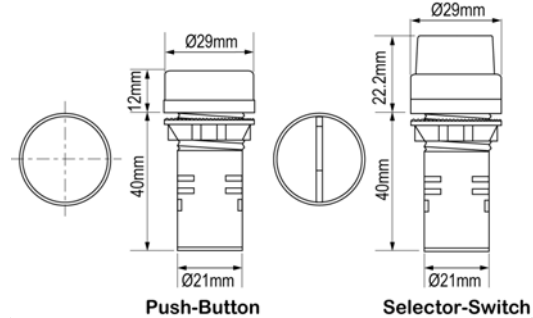

Data Sheet: **SE-IND-22D-S11-MB**

Ergonomically Designed with Matt-Aluminized Bezel

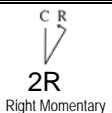

Solitronics Engineering Ltd E-mail: info@solitronics.com

- IEC Ø22mm General Purpose Push-Button & Selector-Switch for Simple Fast & Easy Installation;
- Compact Mono-Block Ergonomically Designed Black-Body with Matt-Aluminized Bezel;
- Red, Green, Yellow, Blue, White, and Black Button or Lever with Matt-Aluminized deco-strip;
- Compact-Size with 40mm Maximum Behind-Panel-Length; Finger-proof Protected Screw-Terminals.

Product Description	Contacts	Ordering Code	Button Color	Switch Action	Remarks		
Ø22mm Compact Push-Button Switch  IP40	1N0+1NC	SE-22MB-PB-11-MM- X	R =Red G =Green Y =Yellow B =Blue K =Black	Momentary			
	0N0+2NC	SE-22MB-PB-02-MM- X					
	2N0+0NC	SE-22MB-PB-20-MM- X					
	1N0+1NC	SE-22MB-PB-11-TT- X		Maintained			
	0N0+2NC	SE-22MB-PB-02-TT- X					
	2N0+0NC	SE-22MB-PB-20-TT- X					
Ø22mm Compact 2-Position & 3-Position Selector-Switch  IP40	1N0+1NC	SE-22MB-SS-11-2T-K	K =Black (with Matt-aluminized deco-strip)	 2R Right Momentary			
	0N0+2NC	SE-22MB-SS-02-2T-K				 2T Maintained	
	1N0+1NC	SE-22MB-SS-11-2R-K		 3B L & R Momentary			
	0N0+2NC	SE-22MB-SS-02-2R-K				 3T L, C & R Maintained	
	1N0+1NC	SE-22MB-SS-11-3T-K					
		2N0+0NC		SE-22MB-SS-20-3T-K			
		1N0+1NC		SE-22MB-SS-11-3B-K			

Order Code (18 Digits): SE-22MB-XX-XX-XX-X

SE-22MB	-	XX	-	XX	-	XX	-	X
22D Compact (Mono-Block) Switch		Push-Button-Switch or Selector-Switch		Contact-Block		Switch-Configuration		Code for Button-Colour, Lever Colour and Body-Colour
Push-Button-Switch: Black-Body with Matt-Aluminized-Bezel and choice of different Push-Button Colours. Selector-Switch: Black-Body with Matt-Aluminized-Bezel and Black Short-Lever with Matt-Aluminized deco-strip.		PB =Push-Button SS =Selector-Switch		11 =1N0+1NC 20 =2N0+0NC 02 =0N0+2NC		For Push-Buttons: TT =Maintained MM =Momentary For Selector-Switches: 2T =2-Position Maintained 1N0+1NC & 0N0+2NC only 2R =2-Position Momentary R-to-Center 1N0+1NC & 0NC+2NC only 3T =3-Position L, R & C Maintained 1N0+1NC & 2N0+0NC only 3B =3-Position L-to-C & R to C Momentary 1N0+1NC Only		Push-Button Colour R=Red; G=Green; B=Blue; Y=Yellow; K=Black Body: Black with Matt-aluminized-Bezel Selector Short-Lever Colour K=Black With Matt-aluminized deco-strip Body: Black with Matt-aluminized-Bezel

Remarks: Due to continuous development, all specifications are subject to change without prior notice. Please confirm all details at time of ordering.
 Packing: 10 pcs per inner box; 500 pcs per Export Carton; GW: Approx. 13.0 Kg.

Copyright by Solitronics Engineering Ltd. Not to be reproduced without written permission from Solitronics Engineering Ltd.